



赣工机械设备科技(东莞)有限公司

TEL: 15920631511

PART NUMBER: STD126

REVISION: H

STD126

H

Product Specifications

Model Number	MAX. PRESS.		MAX. SPEED	HP	kW	Net Wt.	
	bar.	PSI				lbs.	kg
4AM-ARV-119	7.0	100	3,000 RPM	1.7	1.25	11	5.0
4AM-ARV-120	7.0	100	3,000 RPM	1.7	1.25	11	5.0

CONFORMS TO EUROPEAN STANDARD EN13463-1  
NON-ELECTRICAL EQUIPMENT FOR EXPLOSIVE  
ATMOSPHERES GROUP II CAT 2 (GAS & DUST),  
PROTECTED BY CONSTRUCTION (SURFACE TEMP. RATED 135°C).

SOUND LEVEL 87 dB(A) MAX.

NORMAL AMBIENT +1°C. - 120°C.

RELATIVE HUMIDITY 0% - 100%

ENVIRONMENT HAZARDOUS AMBIENT COMBUSTIBLE  
GAS AND DUST +1°C TO +40°C

TECHNICAL DATA SUBJECT TO CHANGE WITHOUT NOTICE.  
DIMENSIONS ARE FOR REF. ONLY UNLESS OTHERWISE SPECIFIED

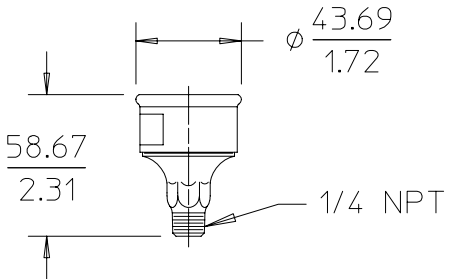
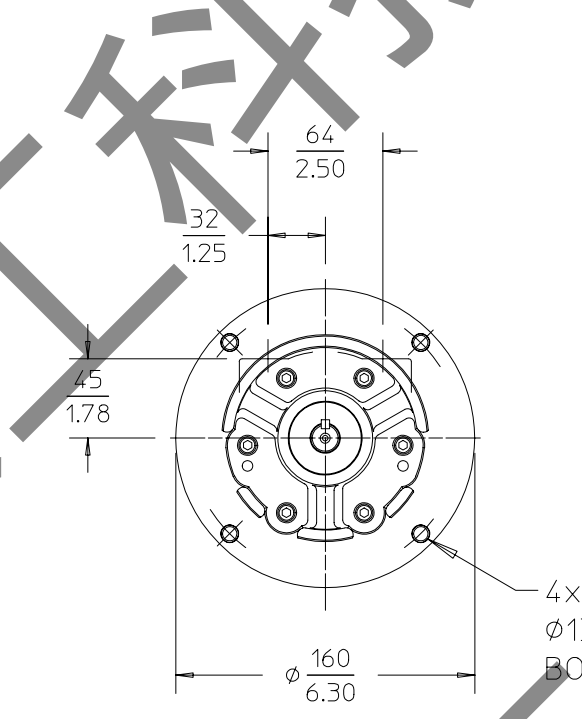
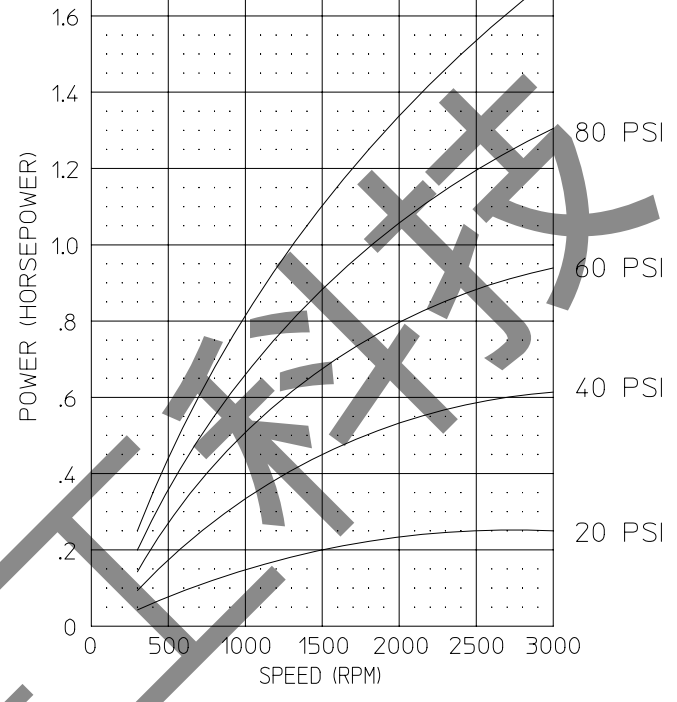
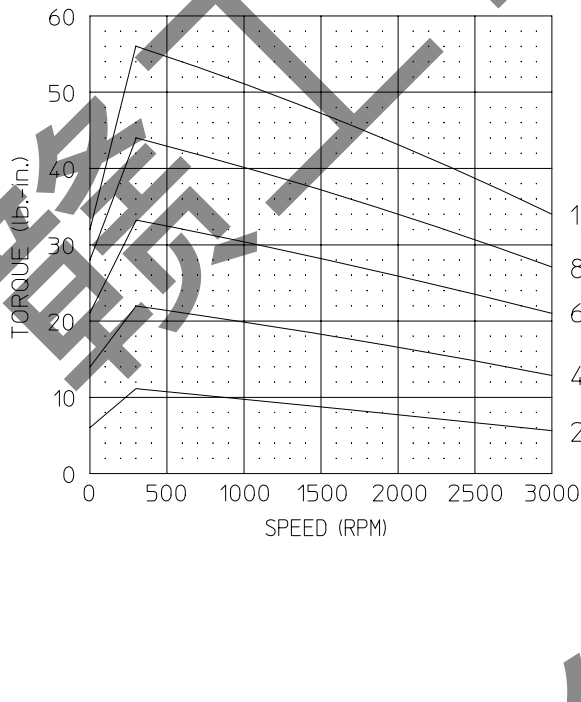
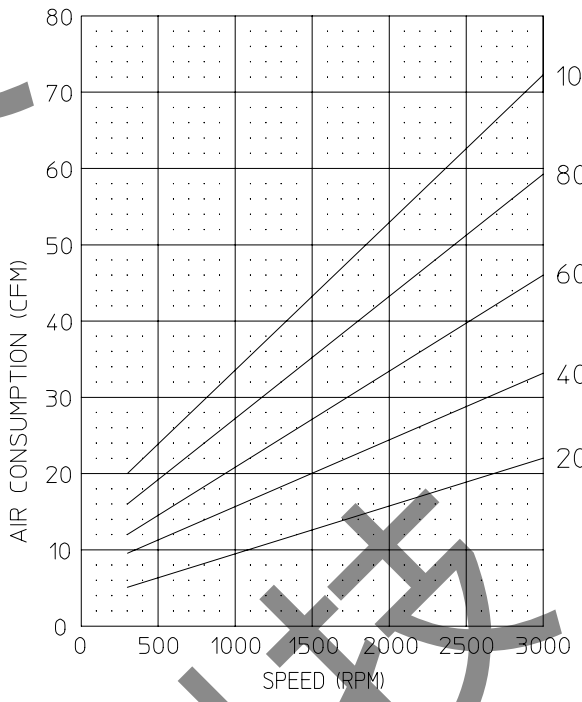
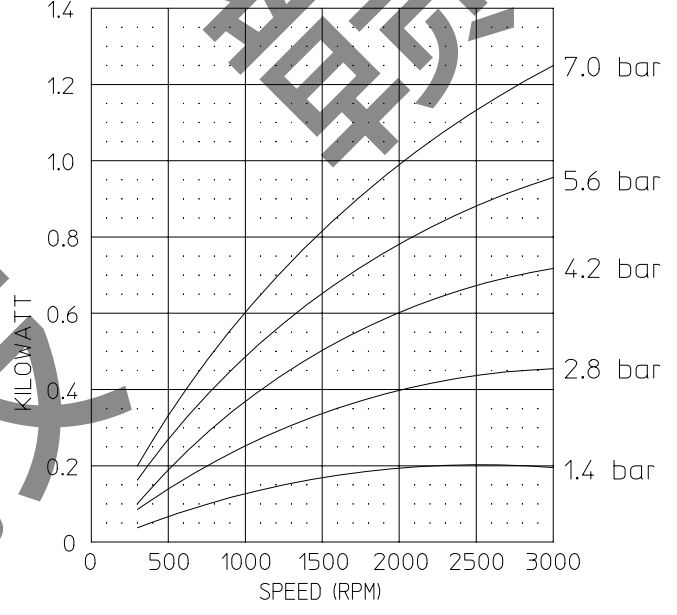
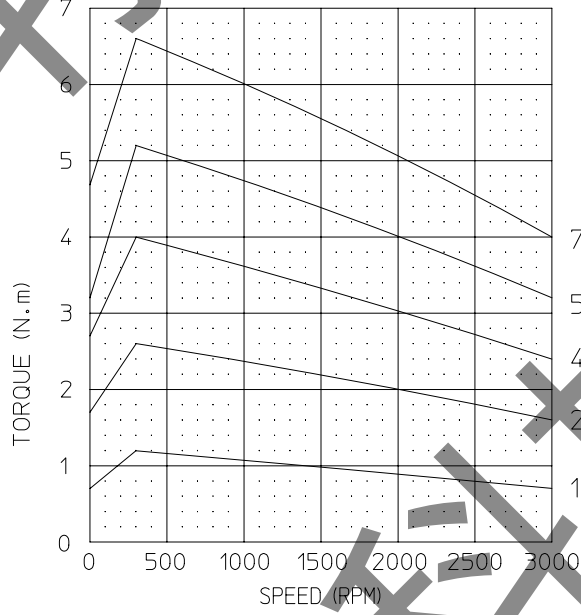
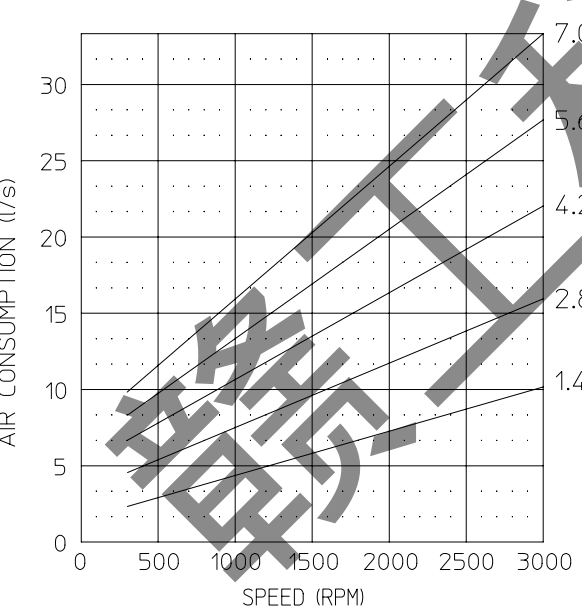

MUFFLER ASM.  
(SHIPPED UNATTACHED)

4x  $\phi 10/38$  THRU  
 $\phi 130.05$  (5.12)  
BOLT CIRCLE

